

# Installation Instructions

SLIMCLASSIC & SLIMHANDSFREE

**PROFESSIONAL INSTALL ONLY**

Do NOT give this manual to end user!

SLIM | CLASSIC



SLIM | HANDSFREE

Manual Version 1

The manufacturer cannot legally offer technical support to non-qualified gate or door installers. End users should employ the services of a professional install company to commission or support this product!



**Tip:** Site Survey BEFORE you begin.



## WARNING

Do not power from the gate controller. Only use the provided UL power supply, otherwise damage may occur and warranty may be void.



# Index

Site Survey	Pg 3
Method 1	Pg 3
Method 2	Pg 3
Cable Distances	Pg 4
Wiring Method 1	Pg 5
Wiring Method 2	Pg 6
Mounting holes	Pg 7
Connecting Relays to Gates & Locks	Pg 7
Power at the Gate	Pg8
Keypad Overview	Pg 8
Keypad Programming	Pg 9
Using the Keypad	Pg 11
Troubleshooting	Pg 11
Change History	Pg 11
Programming an Existing Install	Pg 11

# Site Survey

Before installing this system, please check the cable type which exists and then design the installation accordingly.

The maximum distance between the outdoor and indoor units depends on 4 factors..

1. Type of cable used.
2. Thickness of cable used.
3. If both the outdoor and indoor units are both independently powered, or if power is being sent up the cable.
4. The number of handsets on the system.
5. If the handsfree or classic handsets are being used (handsfree use double the power).

## Method 1 (Power supply at both ends)

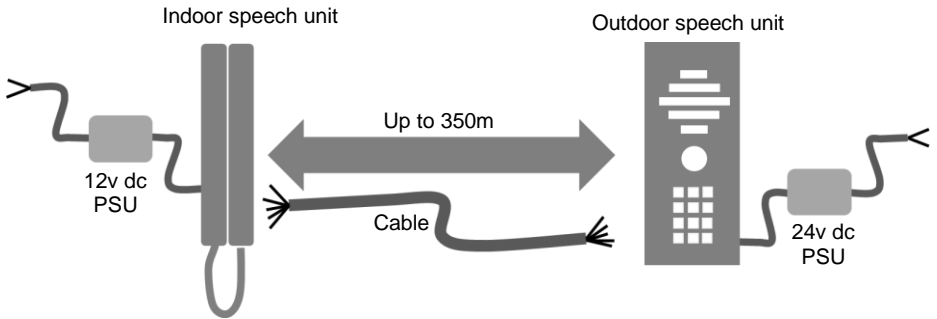

## Method 2 (Power supply at Gate/Door only)

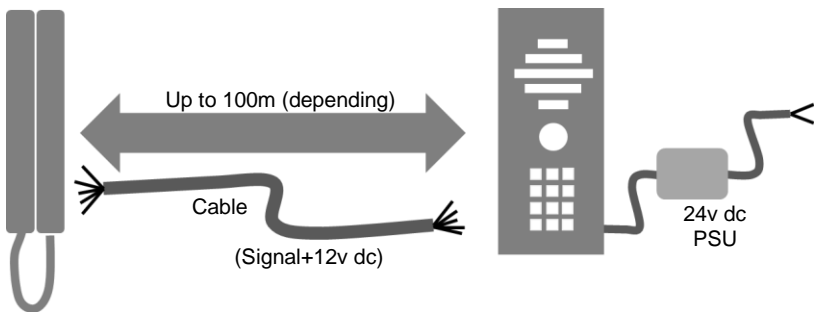

See charts below for approximate guide.

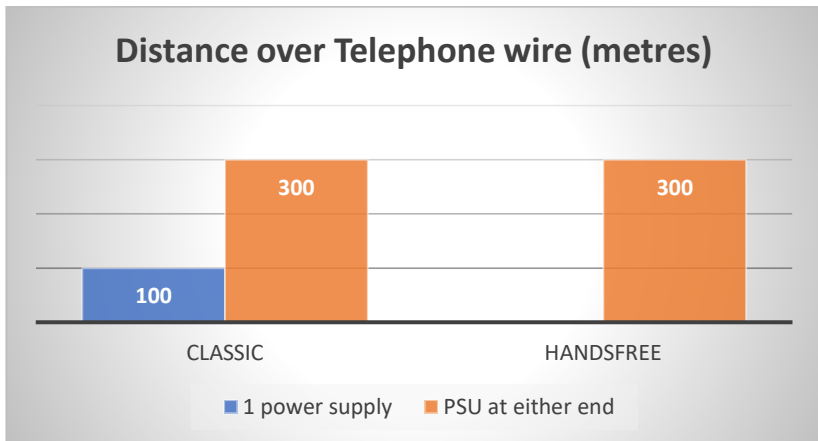
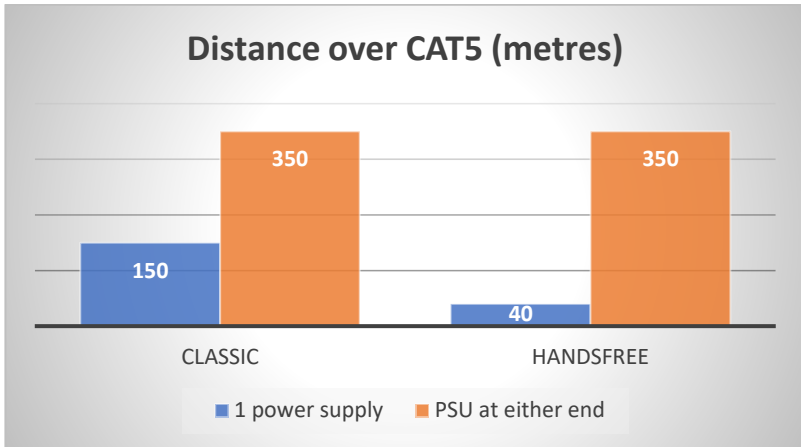

**TIP:** As you can see from the charts, it is much preferred to use a power supply at both ends for longer distance installs. In cases where this is not possible, doubling up on power wires can extend operating range significantly.

# Wiring

## Method 1 (Power supply at both ends)

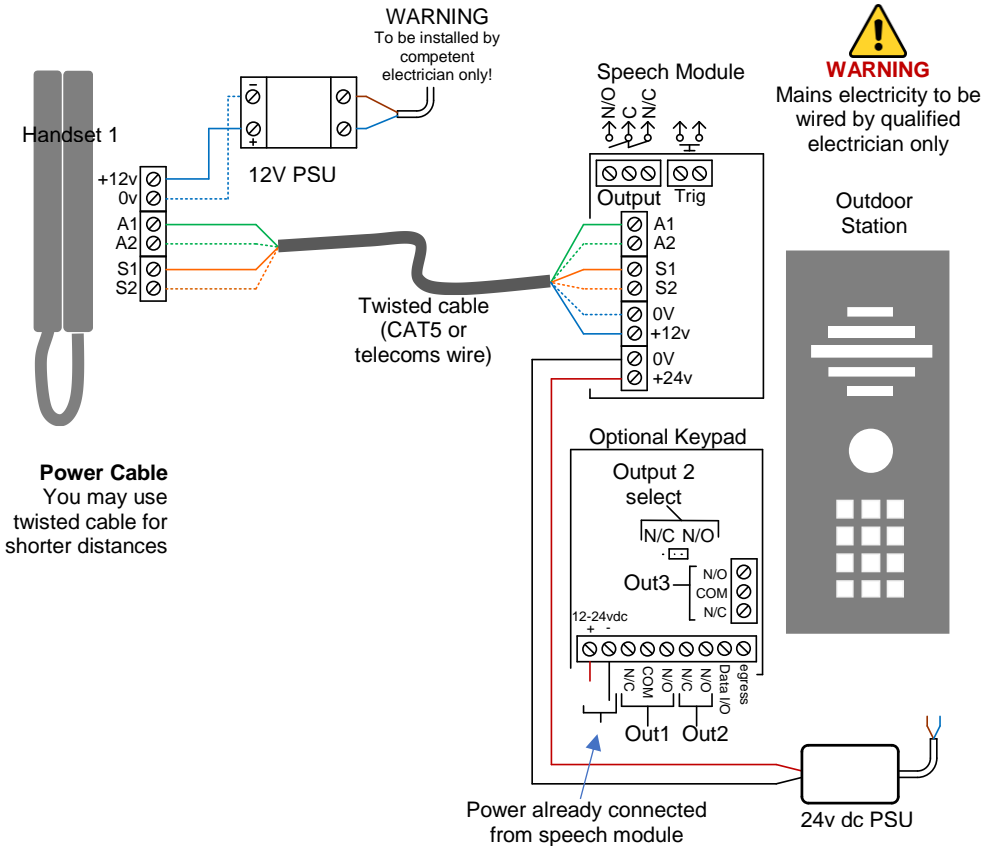

**TIP:**  
Keypad has independent relays from the speech module. Both need connected!!  
Connect in parallel for gate automation or strike locks, and in series for magnetic lock control.

## Method 2

(One power supply used at outdoor unit)

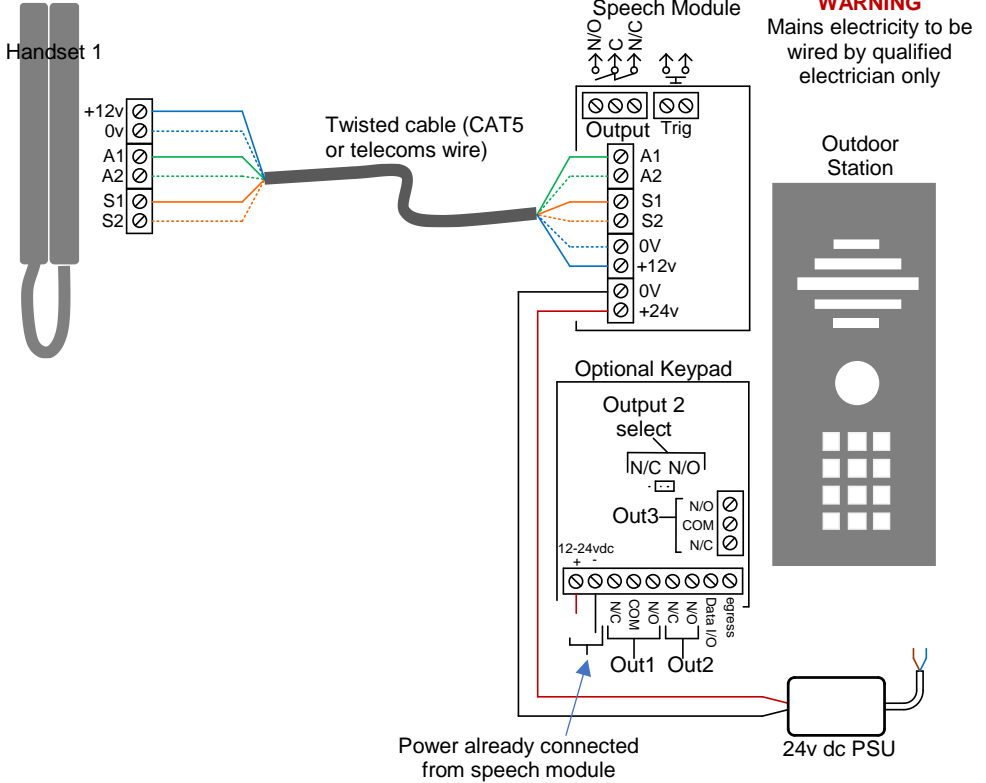

### TIP:

Keypad has independent relays from the speech module. Both need connected!!  
Connect in parallel for gate automation or strike locks, and in series for magnetic lock control.

# Mounting Handsets

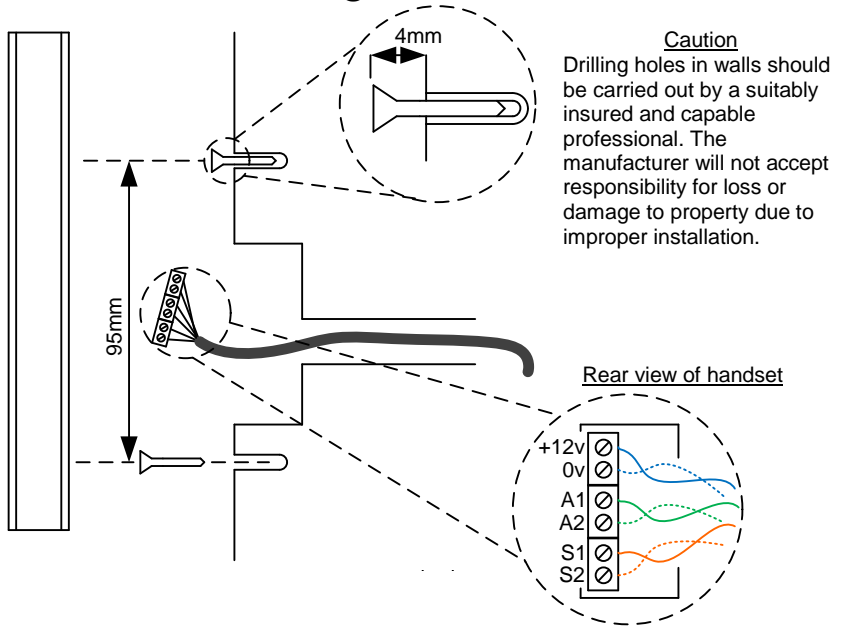

# Connecting Relays to Gates & Locks

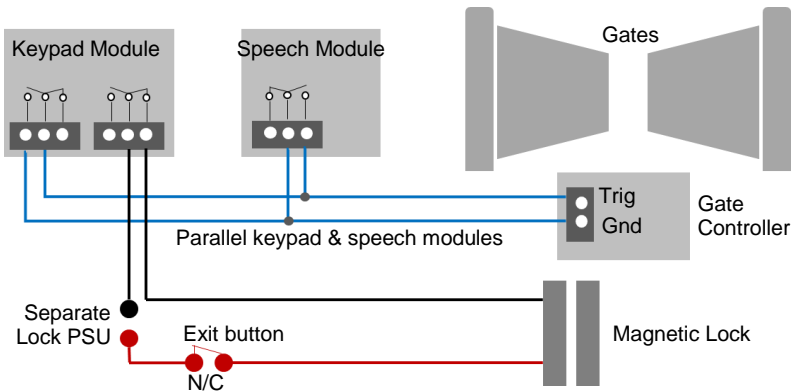

# Power at Gate

This intercom comes with a 24v dc power supply for the speech unit. The intercom requires up to 1 amp peak demand at times, therefore power cable is of significant importance. It is preferred the 24v dc PSU is installed within close proximity of the intercom. However, on occasion this may be difficult to achieve. Please adhere to the cable thickness guide below or the device may be damaged and rendered out of warranty by the manufacturer.

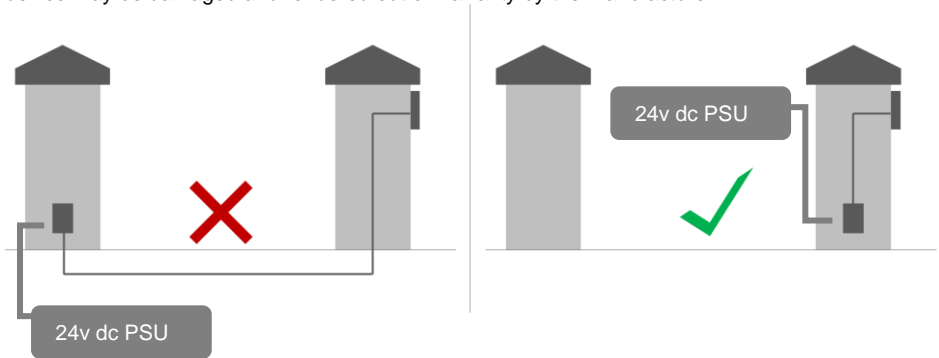

Up to 2 meters (6 feet) use minimum 0.5mm.  
 Up to 4 meters (12 feet) use minimum 0.75mm.  
 Up to 8 meters (25 feet) use minimum 1.0mm.

# Keypad overview

This keypad has 3 outputs, all independent from the intercom/app relays. The diagram below shows the LED indicators which indicate programming and relay status information.

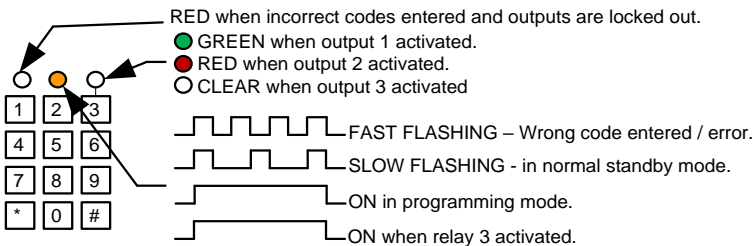

**TIP:** After power up, as a security precaution, the keypad cannot be programmed for 60 seconds. Once this time elapses, you may begin.

**TIP:** Flashing amber LED is normal standby mode!



# Keypad Programming

## Quick start guide

1) Enter programming mode (amber LED should be ON)

0 0 0 0 \* \*

2) Enter a new user code...

1 0 2 0 0 0 ? ? ? ? #

3) Exit programming mode

\* \*

4) Enter the new user code to check the relay clicks.

**Tip:** The engineer code must be the same length as user codes. If using a 6 digit engineers code, then user codes must also be 6 digits long etc.

## Full Keypad programming

Enter programming mode..

0 0 0 0 \* \*

The unit is now in programming mode. Amber LED on the keypad should remain permanently on. 0000 is the default programming passcode.

Exit programming mode..

\* \*

The unit should exit programming mode and the amber LED should start flashing again.

Enter a new ENGINEER/INSTALLERS code...

Go into programming mode firstly then enter the following sequence...

0 1 ? ? ? ? #

Location                      4-8 digit code                      Validate

Replace ??? with your new ENGINEERS code.

Enter or delete new user/Homeowner codes

There are 3 groups of user codes. Group 10 for relay 1, group 20 for relay 2, and group 30 for relay 3. The programming sequence is shown below...

1 0 2 0 0 0 ? ? ? ? #

10= relay 1 codes (1000 available)  
20= relay 2 codes (100 available)  
30= relay 3 codes (100 available)

2= add code  
5= delete code

Memory locations  
000-999 for relay 1  
001-100 for relay 2  
001-100 for relay 3

Pin code 4-8 digits                      Validate

Example: Add user 31 to have access code 5555 operating relay 2...

2 0 2 0 3 1 5 5 5 5 #

Group 2                      Add code                      Location 31                      Pin code 5555                      Validate

### Programming relay output times and modes...

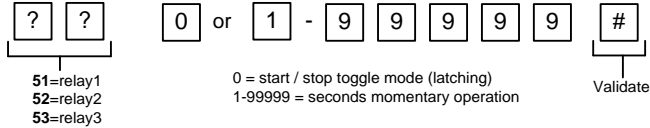

### Delete a user code even if you don't know the code...

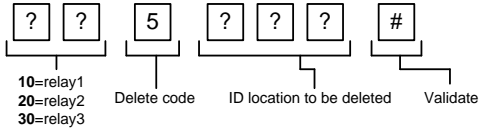

### Delete an entire group of codes

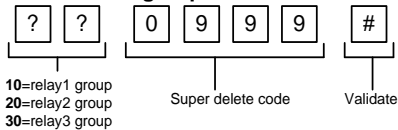

### Programming super user codes...

A super user code can activate any of the 3 relays

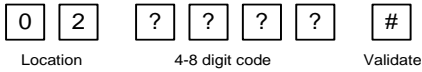

### Restoring defaults

When in programming mode, you can enter the following sequence...

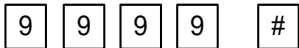

### When the engineers/installers code is forgotten....

- 1) Wire a push button (or replicate with wire link) across the Egress terminal and (-)GND.
- 2) Switch off power for 1 minute.
- 3) Switch ON power.
- 4) during the first 60 seconds, press the EG button once to enable the function.
- 5) Enter the following code..

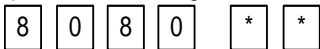

The keypad should now be in programming mode, ready to accept new data. Change the installers/engineers code now as per instructions above.

# Using the keypad

## Using the standard codes...

Once you have exited out of programming mode, simply enter the user code.

## Using super user codes

[?] [?] [?] [?] [#] [1] Activate output 1

[?] [?] [?] [?] [#] [2] Activate output 2

[?] [?] [?] [?] [#] [3] Activate output 3

# Troubleshooting

Q: No communications from gate to handset.

A: Try another handset.

-Check the green status LED is illuminated on the speech unit at the gate.

-Check the handset has been powered on. Press and hold the power button on the handset or check for illumination from the buttons.

-Remove handset and wire to the gate station at the gate with 6 feet of cable and check if that works. If it does, then the cable may have a break or be the wrong type.

Q: First handset works, but second handset does not.

A: Swap them around, and check if the problem follows the handset or remains with the location. If it remains with the location, it is an installation problem. Check wiring, cable gauge used for power etc. If it follows the handset, call technical support. It may have a defect or be damaged.

Q: Communications work but it does not release the gates or lock.

A: Listen for a relay click when the lock release button is pressed. Even better, remove the wires to the lock or gate, use a multimeter on continuity mode, and listen for bell tone when the lock release button is pressed. If that works, then it is an installation problem. Check wiring diagram for tips.

# Change History

Version			Reason for change
P	H	S	
1	1	1	First version.

The manufacturer cannot legally offer technical support to non-qualified gate or door installers. End users should employ the services of a professional install company to commission or support this product!

